



AP AP850(DA)

--802.11ax

D



802.11ax

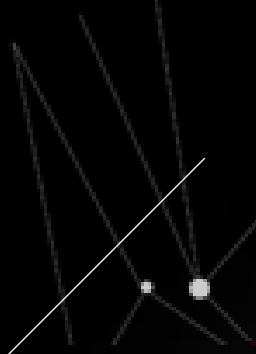

1024-QAM

OFDMA

802.11ac 256-QAM
1024-QAM,
25%

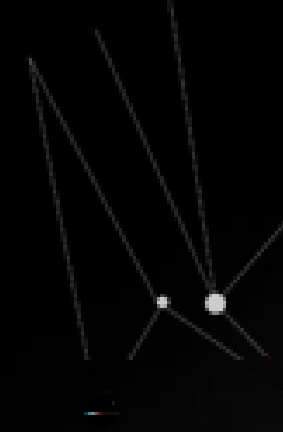

802.11ax

2.4G / 5G

802.11ac 5GHz 802.11ax
2.4G 5G
802.11a/b/g/n/ac

MU-MIMO

802.11ac MU-MIMO
802.11ax MU-MIMO UL/DL

TWT

TWT Target Wakeup Time

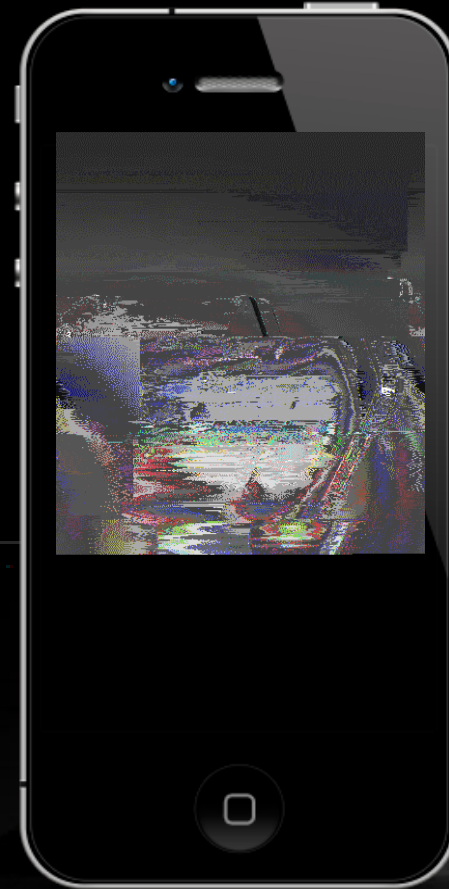

802.11ax



802.11ax

80MHz
160MHz
8

433Mbps
1201Mbps
9.6Gbps

600Mbps

MU-MIMO

OFDMA

BSS-COLOR

CCA

802.11ac 4

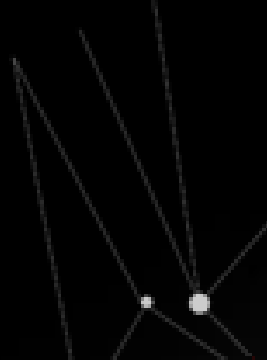

RG-AP850(DA)



RG-AP850(DA)

	802.11ax	802.11ax	802.11ac Wave2	802.11ac Wave1	802.11a/b/g/n
	(30°	60°)		
	2.4G+5.8G+5.2G	2.4G 2x2 MIMO+5.8G 2x2 MIMO+5.2G 4x4 MU-MIMO			
	8	2X2+2X2+4X4			
	5725 - 5850MHz (a/n/ac VHT80)	5150 - 5350MHz (a/n/ac/ax HE160)	2400 - 2483.5MHz (b/g/n/ac,VHT40)		
	2.4G	6.067Gbps	400Mbps		
	5.8G		867Mbps		
	5.2G		4.8Gbps		
	20dBm				
	3	10/100/1000BASE-T			
	LAN1/LAN2	POE			
	LAN3		12V/1.5W		
	1	USB2.0			
			DC 48V/0.6A		
	802.3af	802.3at	PoE		
	802.3at				

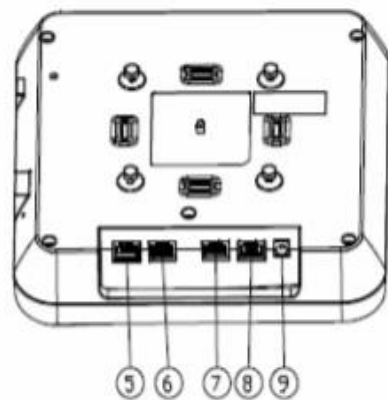
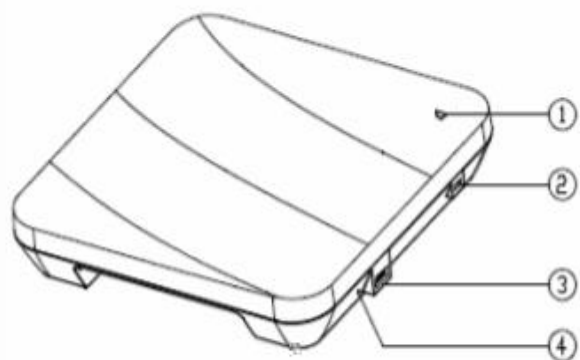

注释:

- ① 指示灯
- ② 笔记本电脑锁
- ③ USB 接口
- ④ Reset 按键
- ⑤ Console 口
- ⑥ LAN3/IOT 网口
- ⑦ LAN2/PoE 网口
- ⑧ LAN1/PoE 网口
- ⑨ 48V 直流适配器输入口

—		AP	/		
3Hz			AP	uboot	
—			AP		
3Hz		AP		Link down	
—		AP		CAPWAP	
3Hz		AP			
—		AP		CAPWAP	
3Hz		AP		CAPWAP	
3Hz	2		AP		AP
				2S	

AP850(DA)

—	AP /	
3Hz	AP	uboot
—	AP	
3Hz	AP	Link down
—	AP	
3Hz	AP	
		2S
		3S

北京 -



AP850(DA)

LAN

ap-config

ap-interface wireport 1 port-group 1

ap-interface wireport 2 port-group 1

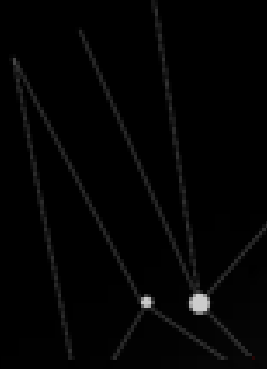

AP850(DA)

11AX

AP

11ax

11ax

STA

AP

11ax

AP

11

AP850(DA)

11AX

	mu

AP

MU MIMO

802.11AC

802.11AX

STA



智慧校园

智能家居

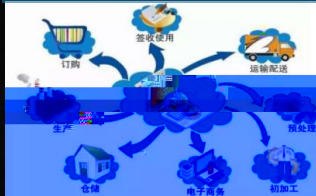

智能



AP850(DA)

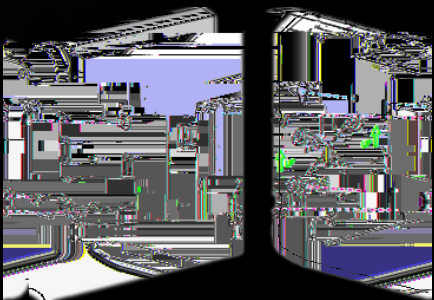

1.

AP850(DA)-bracket

AP

2.

logo

60°k

30°

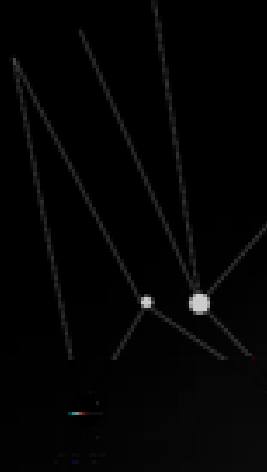

1. AP850(DA) V1.00 LAN1 LAN2
LAN1 LAN2

PoE

PoE

PoE

AP

PoE

AP

PoE

AP850 DA V1.2x

2.

3. AP

AP

2m

4. LAN3/IOT

5. DC POE

6. 802.3af 802.3at PoE



THANKS

29

A 11

100036

Office Tel: 010-5171 5999 Fax: 010-5171 5872

www.ruijie.com.cn