

## 运营商4G网络

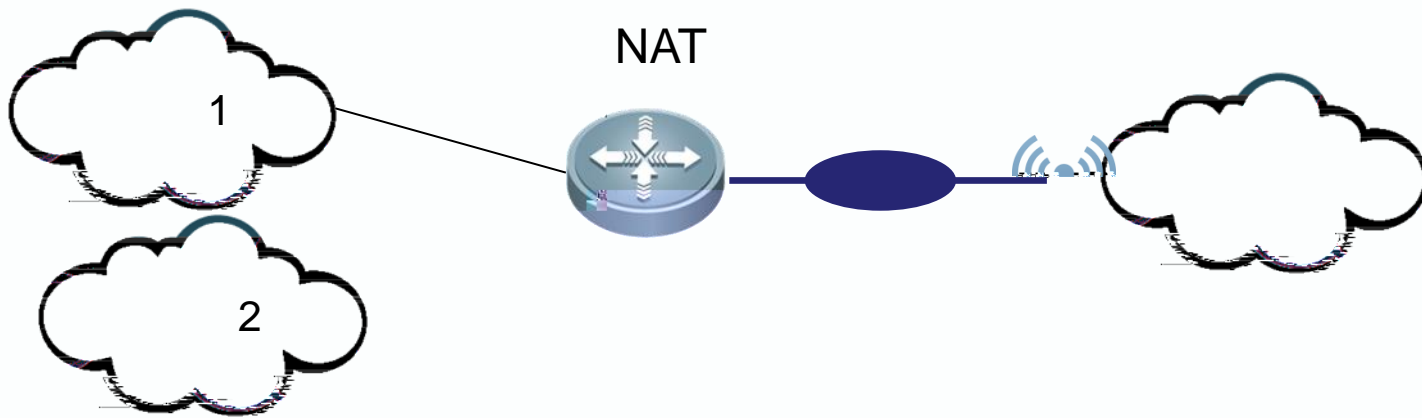





4G

4G

4G

4G

DHCP

WIFI

4G

NAT





RNS  
IP  
4G  
IP,

TRACK



dr

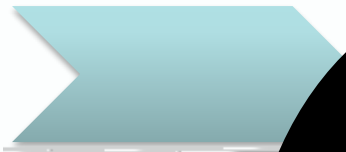



wifi      vlan

wifi      wifi  
AP      vlan100

WIFI	4G
vlan SVI	1      1

wifi  
vlan

wlan id





**Riimo**

[www.riimo.com](http://www.riimo.com)



**Riimo**

[www.riimo.com](http://www.riimo.com)

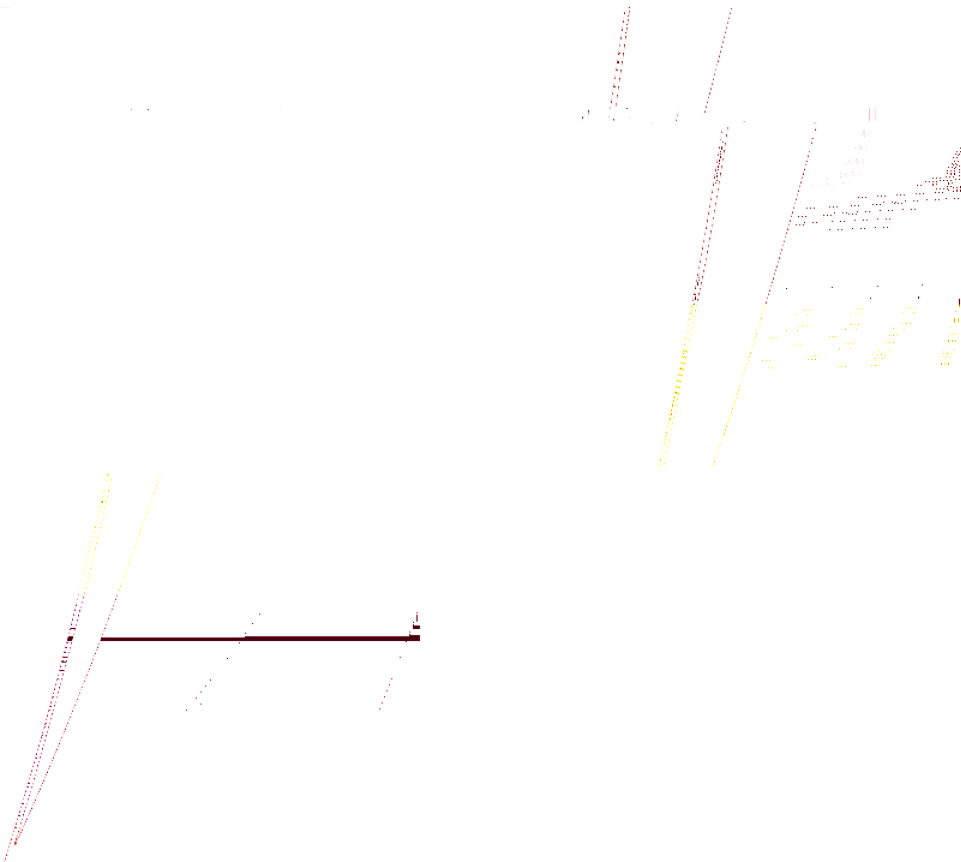









**Rumo**

WWW.TIHOE.COM

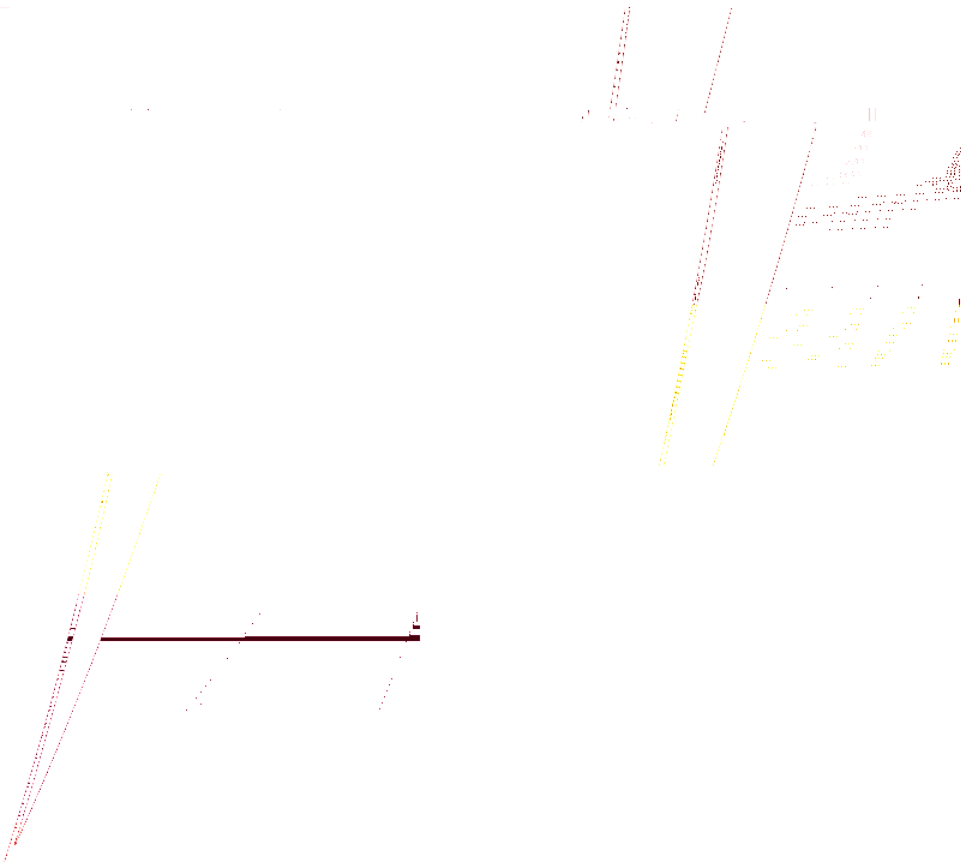

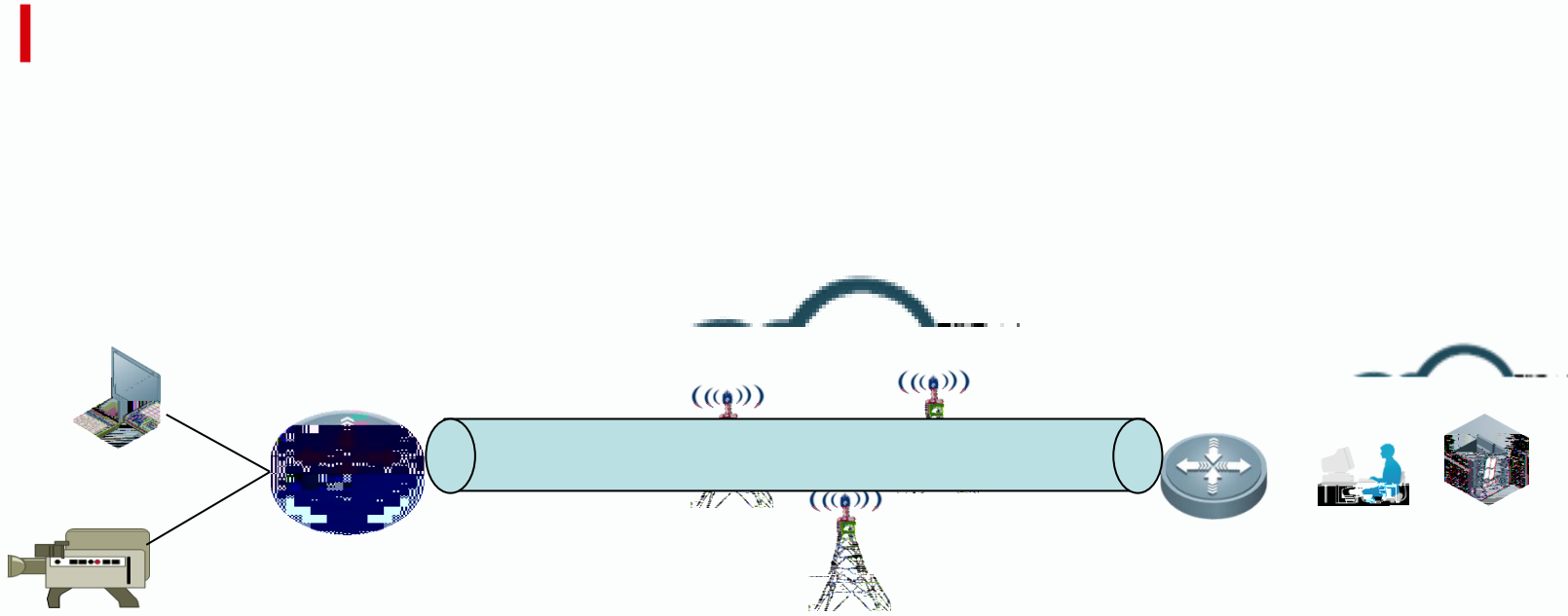

4G

4G

4G  
AAA  
L2TP VPN

NAT

VPN  
4G  
IP

L2TP VPN

4G

L2TP VPN

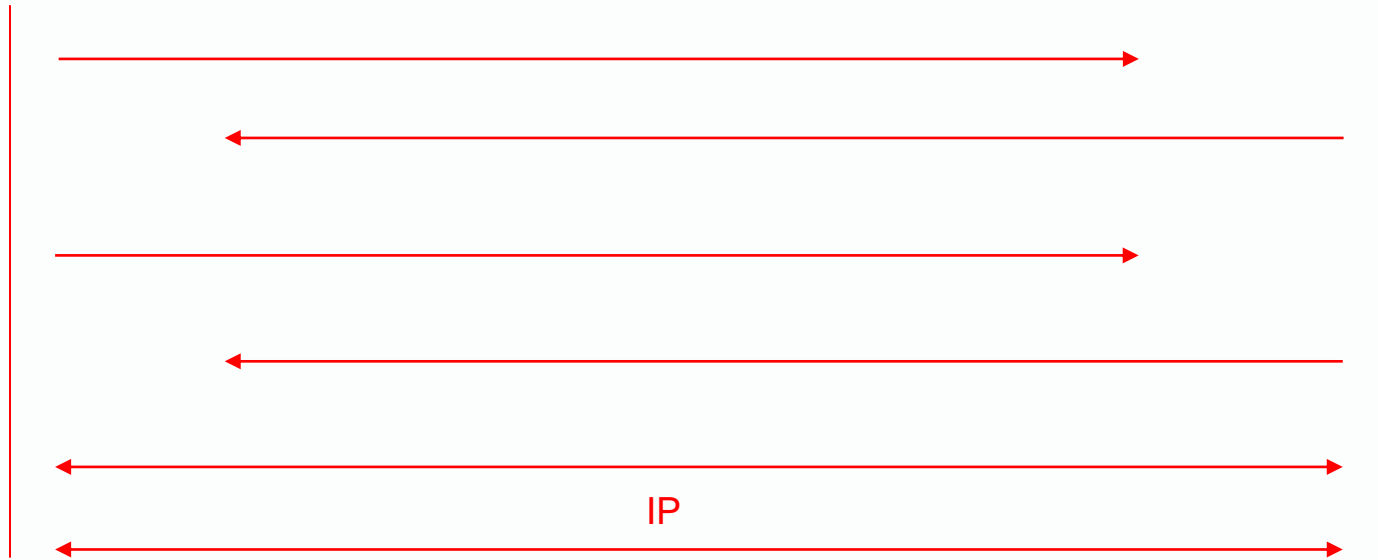
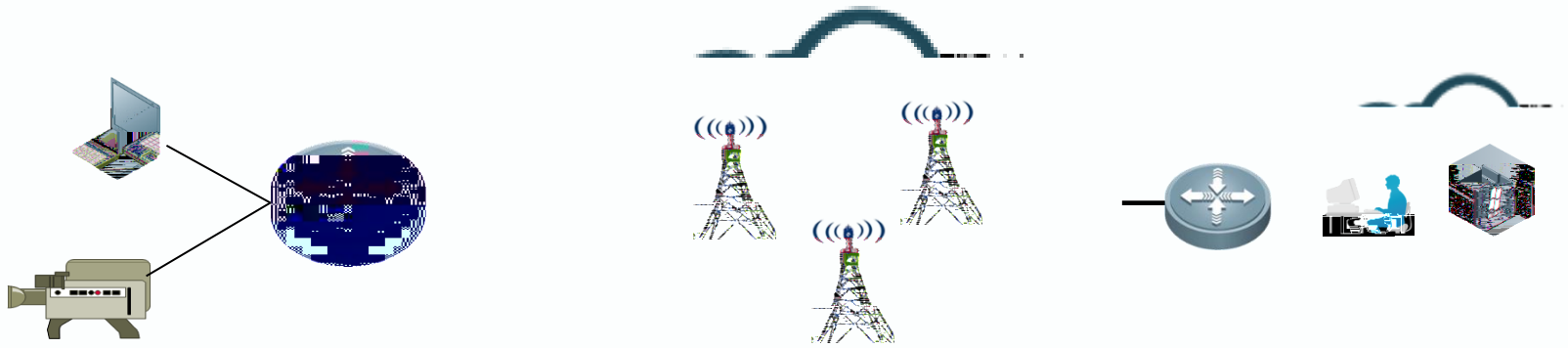



**Runo**

[www.runo.com](http://www.runo.com)



APN

APN



RNS IP IP,

4G

TRACK









ACL

video

video 4G



WAN-TA





**Riimo**

[www.riimo.com](http://www.riimo.com)

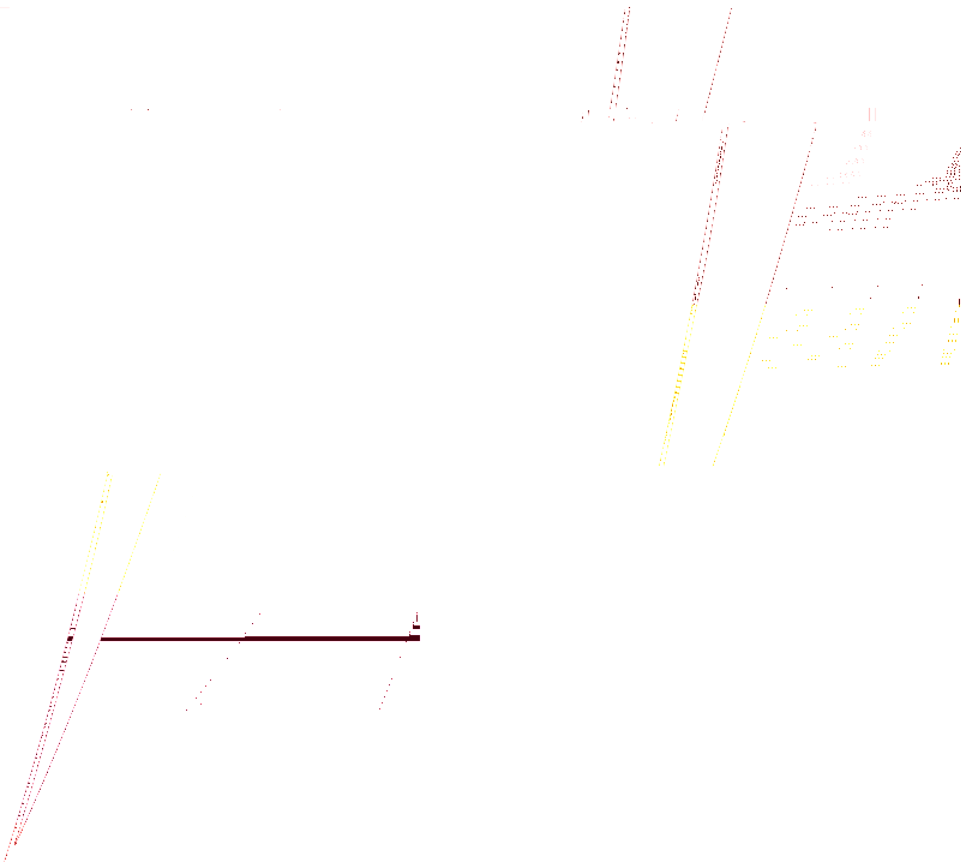

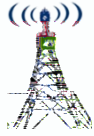
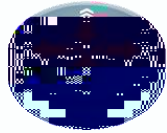
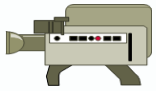

4G

4G

4G

NAT

VPN

Ipssec VPN 4G  
IP

VPN  
Ipssec VPN

VPN

VPN

ipsec

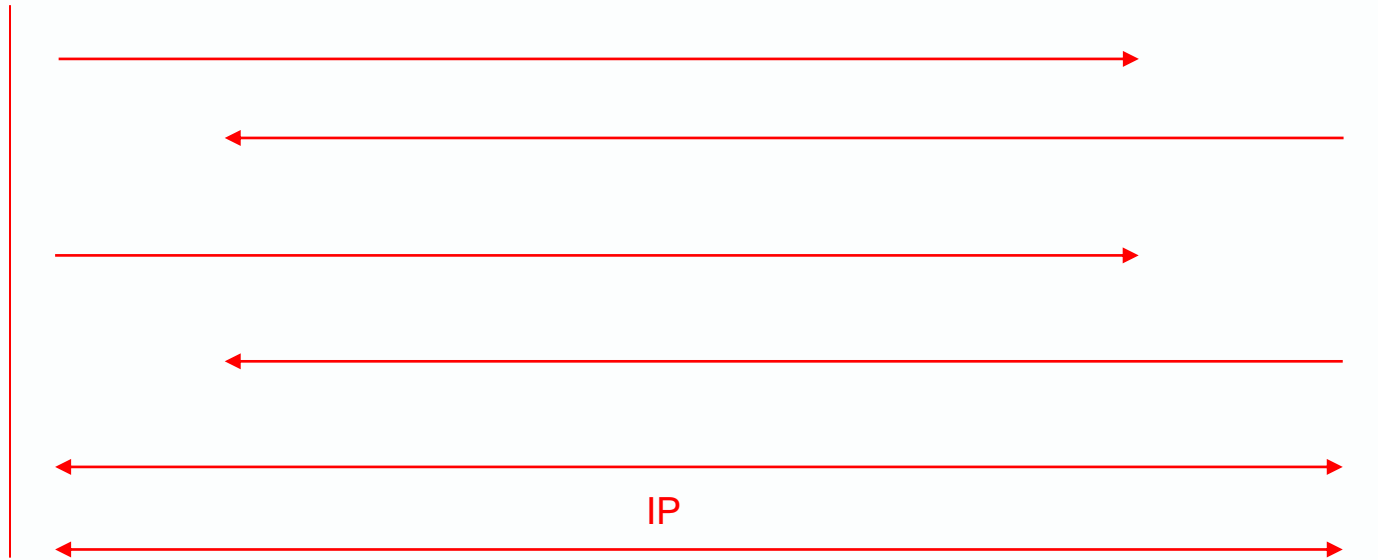
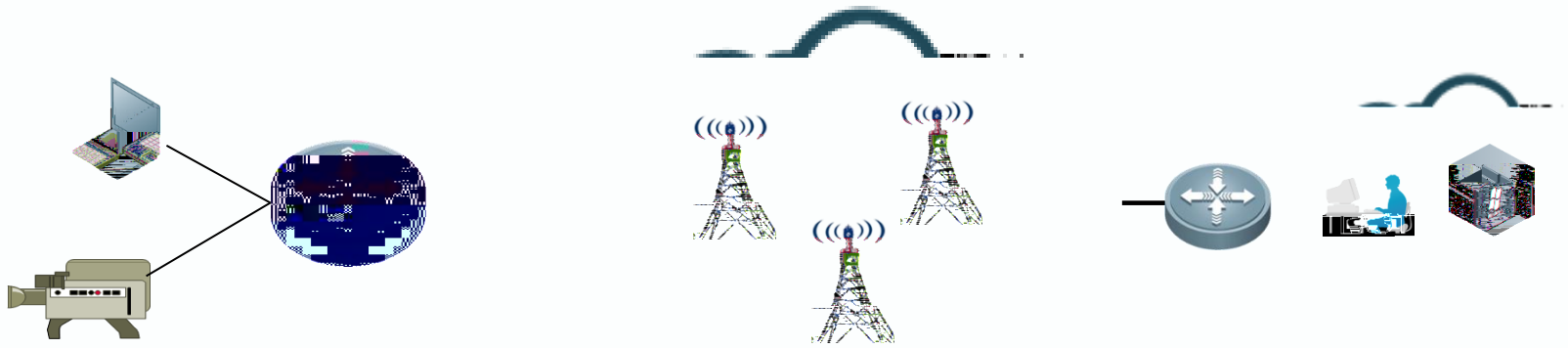







RNS

IP  
4G

IP,

TRACK



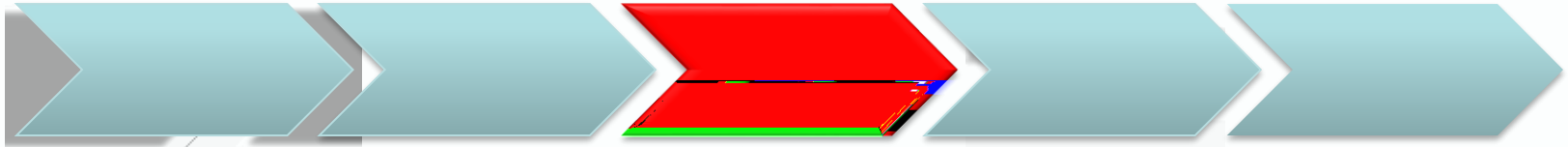

ACL

Ipsec DPD

isakmp

```
crypto isakmp key 0 ruijie hostname xxx.xx.com
```

ipsec

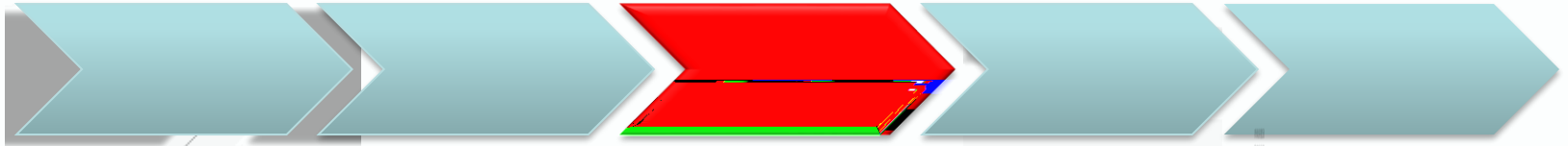







**Riimo**

[www.riimo.com](http://www.riimo.com)





**Riunoro**

[www.riunoro.it](http://www.riunoro.it)

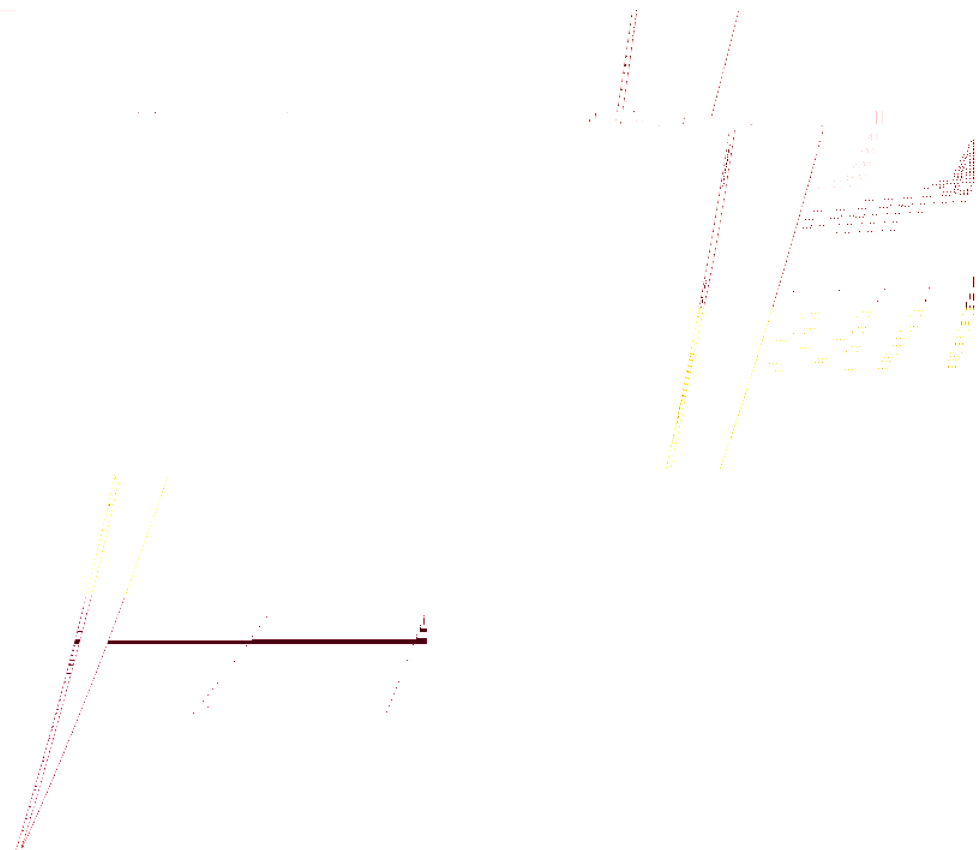



4G

4G

4G  
VPN  
GRE  
L2TP/IPSEC VPN

NAT      VPN

GRE  
IP  
GRE      VPN      4G





**Rumo**

WWW.TIHOE.COM





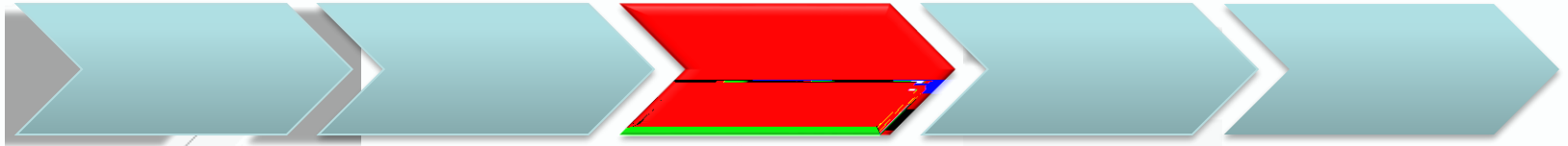

GRE

GRE



x.x.x.x y.y.y.y







**Rumo**

[www.tiempo.com](http://www.tiempo.com)



**Riimo**

[www.riimo.com](http://www.riimo.com)

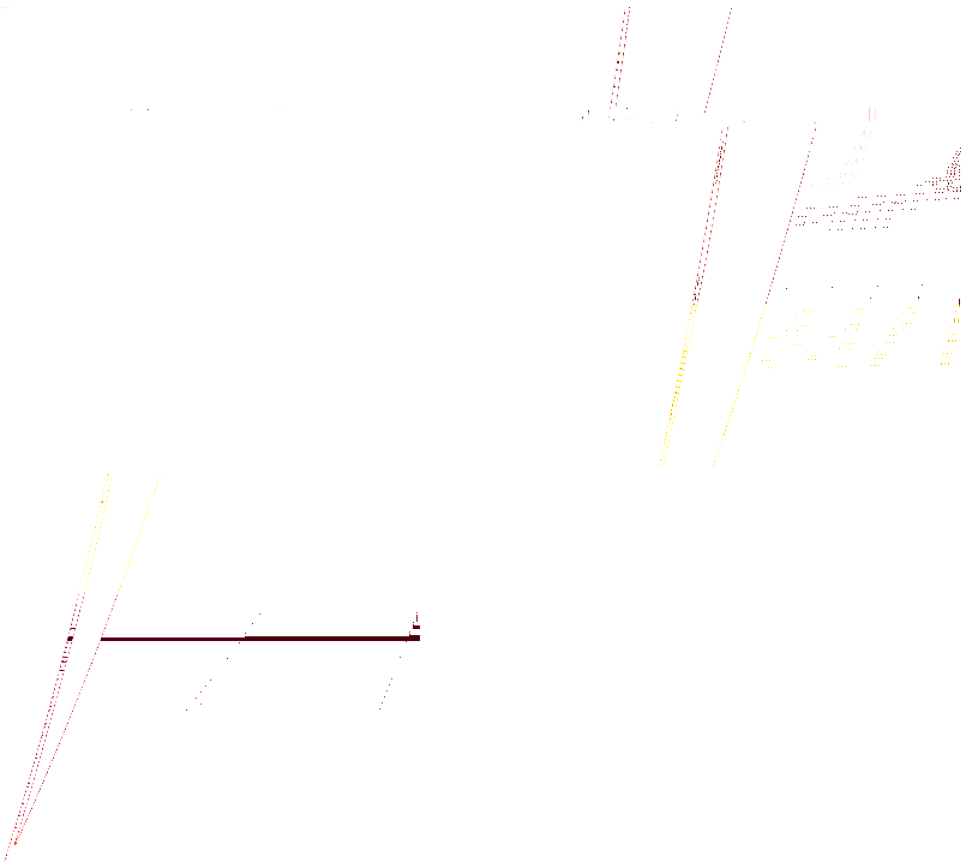

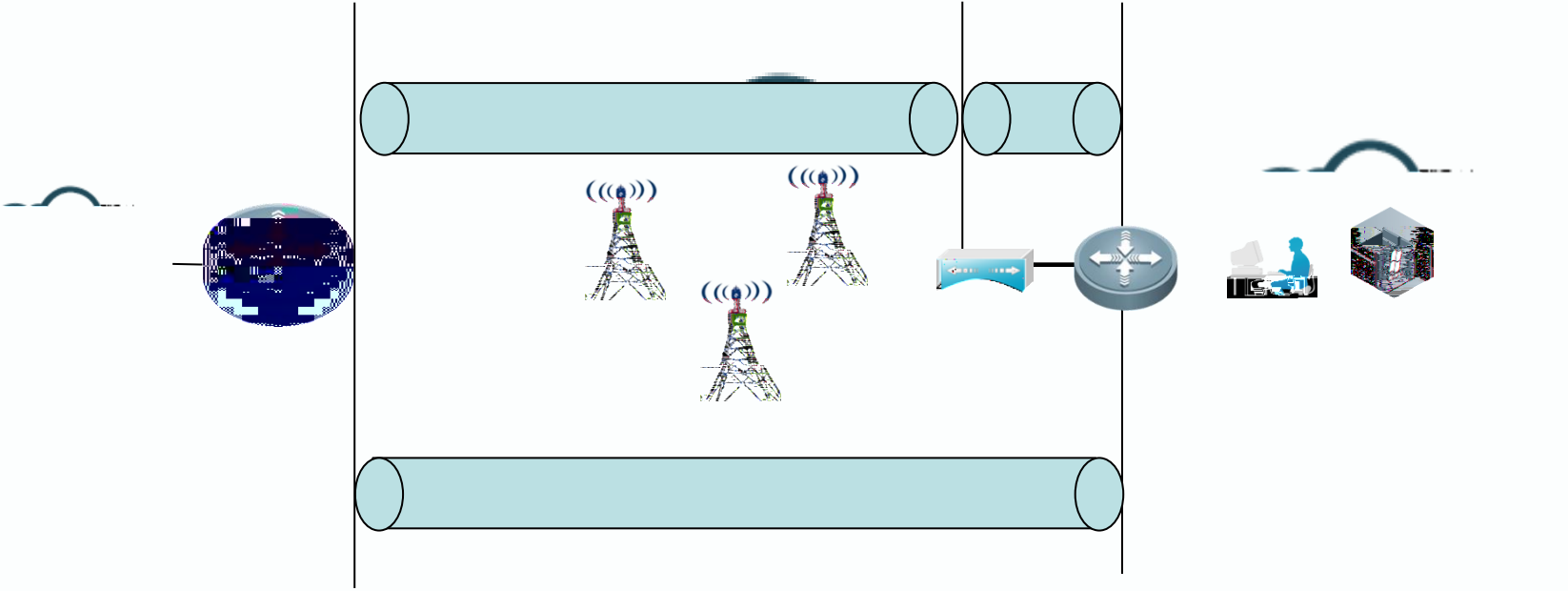

VPDN  
LNS

L2TP

4G

LNS  
4G

PGW/LAC  
IP

VPDN

APN

4G VPDN

14 8

4G VPDN







RNS  
4G 1

TRACK

TRACK 4G



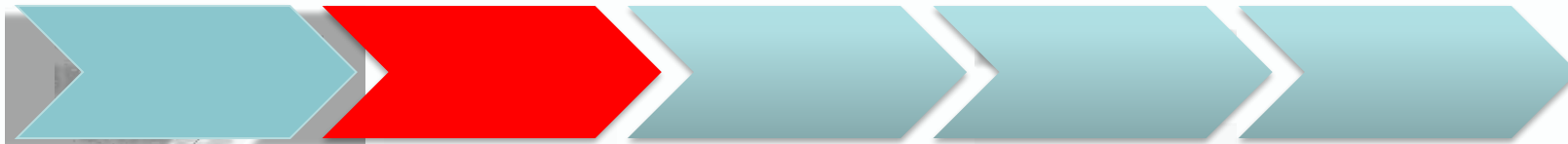

**VPN**

**I2tp Ins**

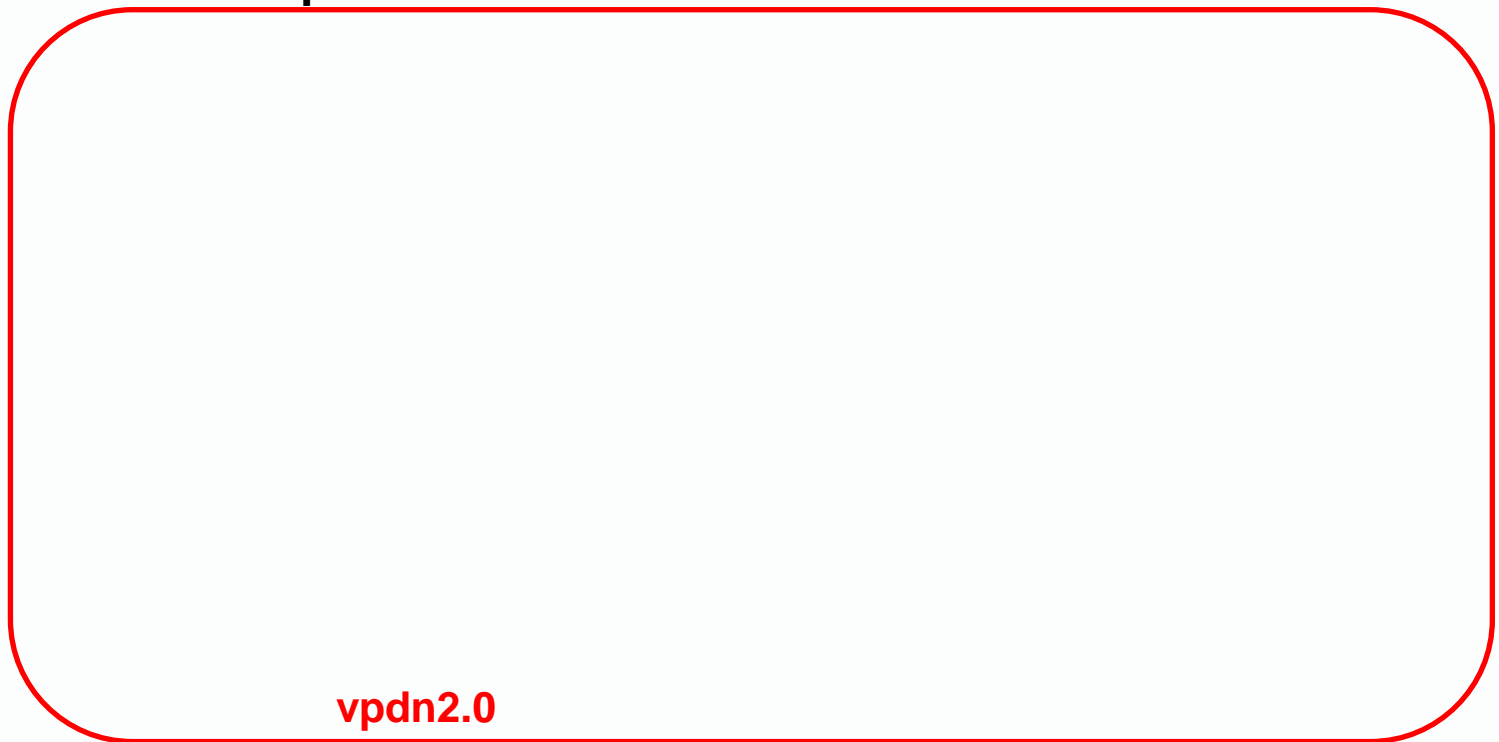

**vpdn2.0**



4G IPsec



**Rumo**

WWW.TIHOE.COM

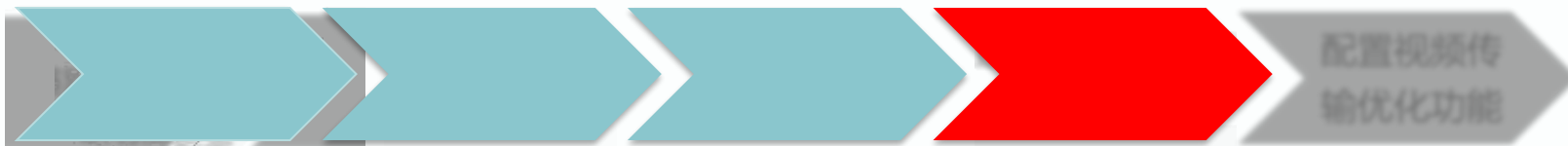





WAN-TA





**Riimo**

[www.riimo.com](http://www.riimo.com)

1



\_\_\_\_\_

\_\_\_\_\_

\_\_\_\_\_

\_\_\_\_\_